

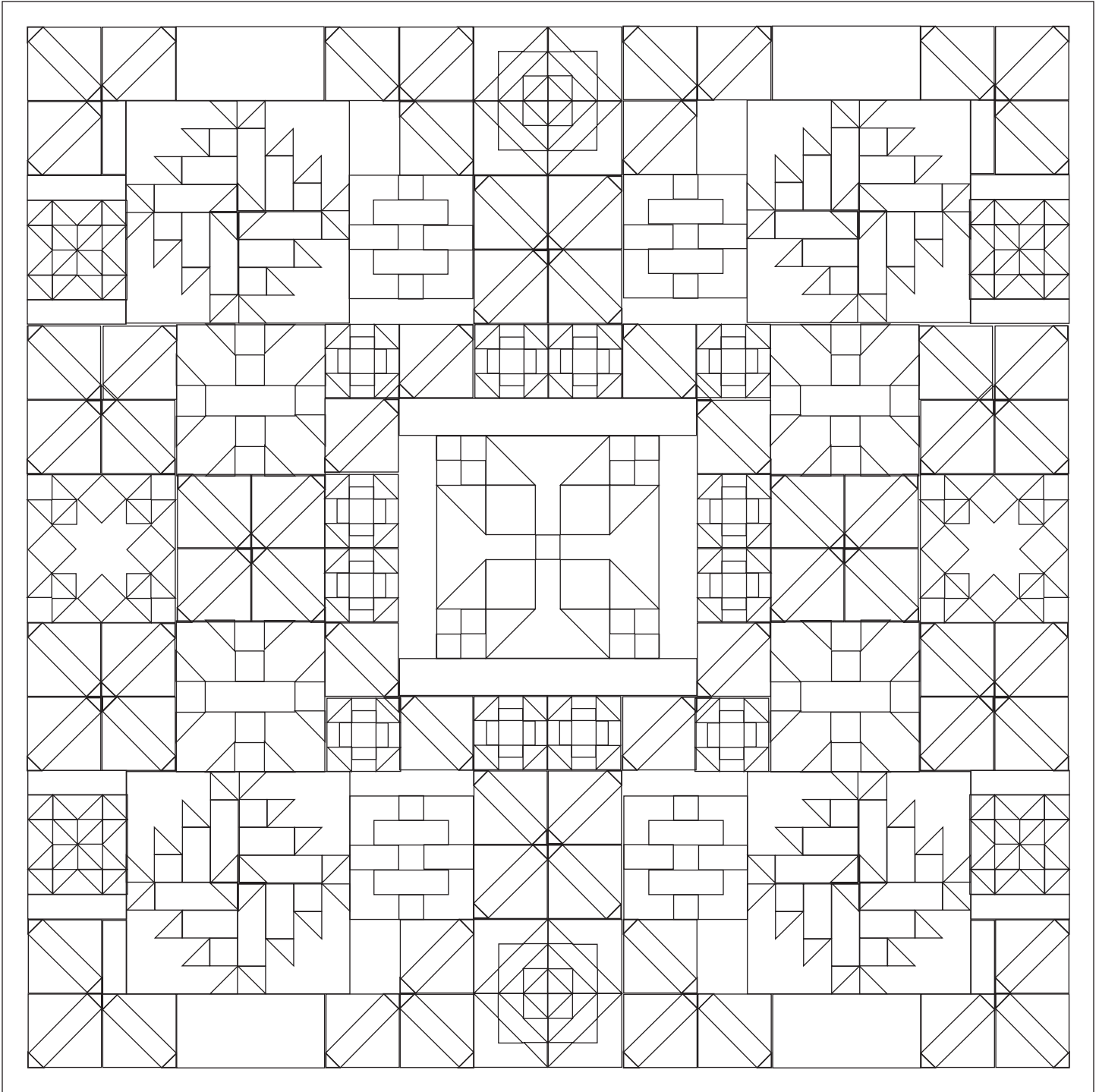

PROJECT PLANNING WORKSHEET

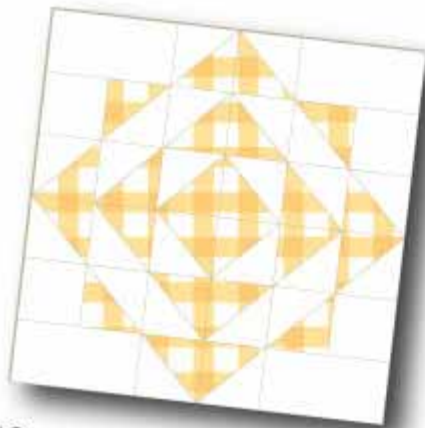

moda BAKE SHOP



Prairie Rose Garden



Applesauce Cross



WEEK 2

EASY

A note about ratings for this quilt-along: Overall, the quilt is rated as Moderate, but many of the blocks fall into the Easy category. You will see the ratings vary between Easy and Moderate from week to week. For more information about what these ratings mean, click on the graphic above.

This is part 2 of a 13 part quilt-along series. Find the rest of the posts in this series by clicking on the links at the end of this post.

Welcome to Week 2 in Oda May's School of Sewing! We are jumping right in this week with two different blocks.

Some notes:

- Use a scant 1/4" seam.
- Depending on your cutting method, you may have extras each week of common sizes used throughout the quilt. I suggest you label a couple of plastic bags for "2 1/2" squares" and "2 7/8" squares" so you can make use of the extras another week.

Prairie Rose Garden

{from [Prairie Rose Garden Quilt](#) by [Sarah Zimmerman](#)}

INGREDIENTS

From prints, cut (24) 2 7/8" squares

From background fabric, cut:

Cut (24) 2 7/8" squares from background fabric

Cut (8) 2 1/2" squares

Cut (8) 2 1/2" x 4 1/2" rectangles

8/20/2017

Original Recipe can be found at www.modabakeshop.com

Recipes are sometimes altered to correct errors. Please ensure that you have downloaded the most recent Printer Friendly Version before starting your project. If you find a mistake in this pattern, please contact modabakeshop@unitednotions.com.

This is an original pattern not intended for sale.

CUTTING FROM LAYER CAKE

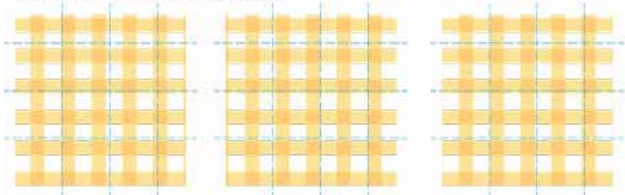

From each of 3 Layer Cake squares, cut (9) 2 7/8" squares. Only 24 squares will be used.

CUTTING FROM FAT QUARTER

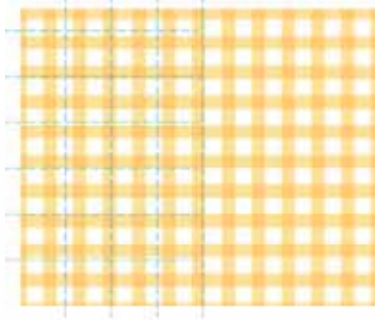

From 1 fat quarter, cut (9) 2 7/8" squares.

INSTRUCTIONS

Make Half-Square Triangles (HSTs)

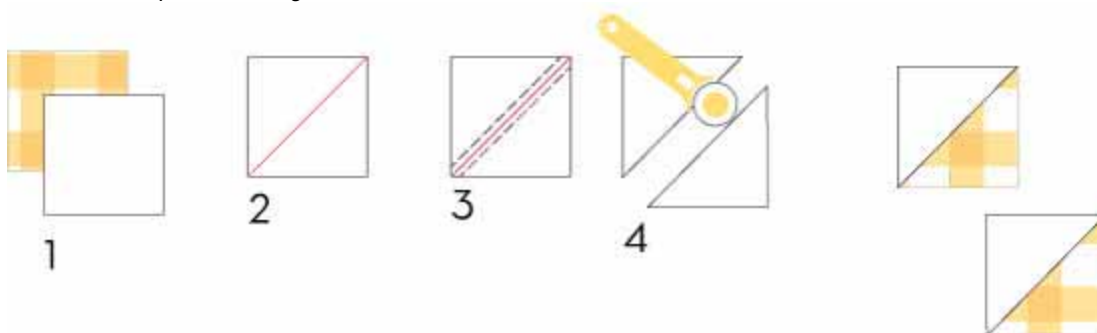

1. Pair (1) 2 7/8" print square with (1) 2 7/8" background square.
 2. Draw a line along the diagonal of the wrong side of one square.
 3. Sew 1/4" away from each side of the drawn line.
 4. Cut apart at the line. Press towards the darker fabric and trim to 2 1/2" square.
- Repeat to make 48 HST units.

Assemble block in rows as shown below, taking care with directional fabric and/or color placement as applicable to your chosen fabrics.

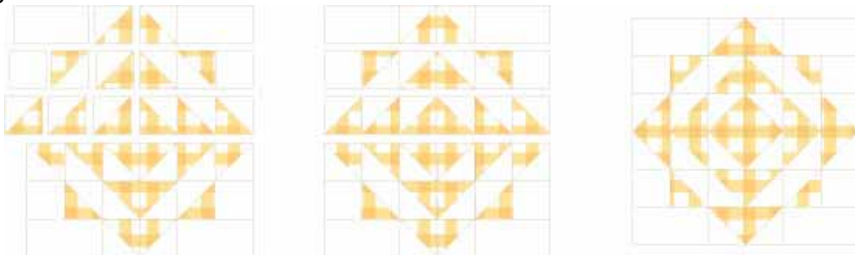

Make (2) 12 1/2" unfinished Prairie Rose Garden blocks.

Applesauce Cross

{from [Applesauce Quilt](#) by [Lauren Terry](#)}

INGREDIENTS

NOTE: The quilt features 64 Applesauce Cross blocks spaced out over the quilt-along. You can either make them all at once or make a few at a time.

From accent fabric, cut:

Cut (8) 1 1/2" x 11 1/2" strips

From background fabric, cut:

Cut (8) 6 1/2" squares

8/20/2017

Original Recipe can be found at www.modabakeshop.com

Recipes are sometimes altered to correct errors. Please ensure that you have downloaded the most recent Printer Friendly Version before starting your project. If you find a mistake in this pattern, please contact modabakeshop@unitednotions.com.

This is an original pattern not intended for sale.

INSTRUCTIONS

Make Applesauce Cross Blocks

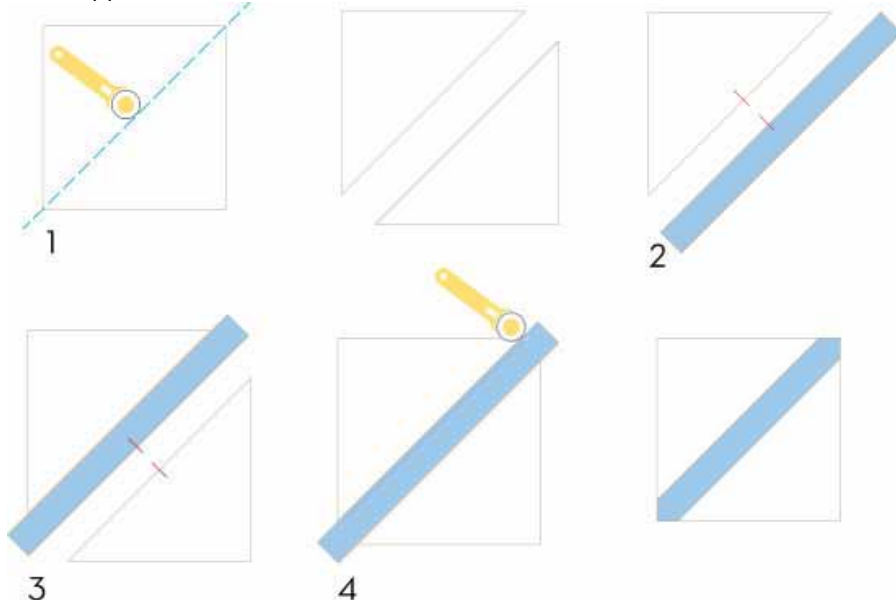

1. Cut 6½” square in two along the diagonal.
 2. Mark the center of each triangle and accent fabric strip. Line up marks on strip and one triangle and pin. Sew and press.
 3. Align marks on opposite edge of strip and remaining triangle. Pin, sew, and press.
 4. Press and trim to 6½” square.
- Make (8) 6½” unfinished Applesauce Cross blocks.

YIELD

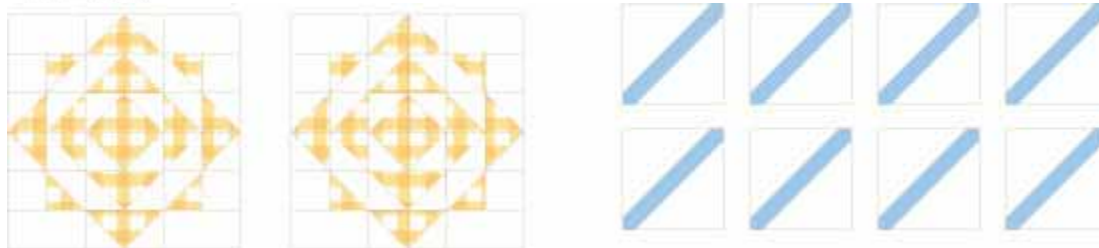

WEEK 1: [Intro to QAL + Fabric Requirements](#)

WEEK 2: [Prairie Rose Garden + 8 Applesauce Cross blocks {this post}](#)

Oda May

8/20/2017

Original Recipe can be found at www.modabakeshop.com

Recipes are sometimes altered to correct errors. Please ensure that you have downloaded the most recent Printer Friendly Version before starting your project. If you find a mistake in this pattern, please contact modabakeshop@unitednotions.com.

This is an original pattern not intended for sale.

moda BAKE SHOP



Tropical Punch



Applesauce Cross



WEEK 3

MODERATE

A note about ratings for this quilt-along: Overall, the quilt is rated as Moderate, but many of the blocks fall into the Easy category. You will see the ratings vary between Easy and Moderate from week to week. For more information about what these ratings mean, click on the graphic above.

This is part 3 of a 13 part quilt-along series. Find the rest of the posts in this series by clicking on the links at the end of this post.

Welcome to Week 3 in Oda May's School of Sewing! This week we are making four new blocks and a few of the Applesauce Cross blocks.

Some notes:

- Use a scant $\frac{1}{4}$ " seam.
- Depending on your cutting method, you may have extras each week of common sizes used throughout the quilt. I suggest you label a couple of plastic bags for "2 1/2" squares" and "2 7/8" squares" so you can make use of the extras another week.

Tropical Punch

{from [Tropical Punch Quilt](#) by [Corinne Sovey](#)}

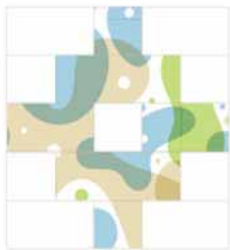

INGREDIENTS

From each of 4 Layer Cake squares, cut:

- (2) $2\frac{1}{2}$ " squares
- (2) $2\frac{1}{2}$ " x $4\frac{1}{2}$ " strips
- (2) $2\frac{1}{2}$ " x $6\frac{1}{2}$ " strips

From background fabric, cut:

- (5) $2\frac{1}{2}$ " squares
- (4) $2\frac{1}{2}$ " x $4\frac{1}{2}$ " strips

INSTRUCTIONS

Assemble block in rows as shown and press toward the darker fabric. Join rows to complete the block. Press.

8/28/2017

Original Recipe can be found at www.modabakeshop.com

Recipes are sometimes altered to correct errors. Please ensure that you have downloaded the most recent Printer Friendly Version before starting your project. If you find a mistake in this pattern, please contact modabakeshop@unitednotions.com.

This is an original pattern not intended for sale.

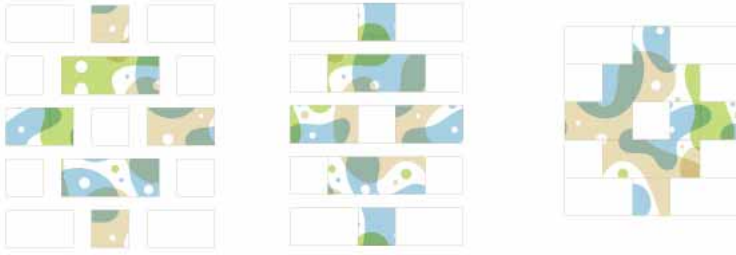

Make (4) 10½” unfinished Tropical Punch blocks.



Applesauce Cross

{from [Applesauce Quilt](#) by [Lauren Terry](#)}

INGREDIENTS

NOTE: The quilt features 64 Applesauce Cross blocks spaced out over the quilt-along. You can either make them all at once or make a few at a time.

From accent fabric, cut:

Cut (6) 1½” x 11½” strips

From background fabric, cut:

Cut (6) 6½” squares

INSTRUCTIONS

Make Applesauce Cross Blocks

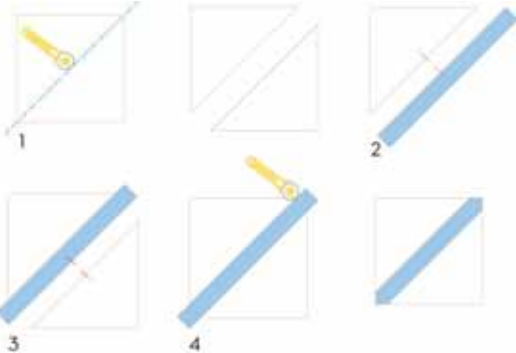

1. Cut 6½” square in two along the diagonal.

2. Mark the center of each triangle and accent fabric strip. Line up marks on strip and one triangle and pin. Sew and press.

3. Align marks on opposite edge of strip and remaining triangle. Pin, sew, and press.

4. Press and trim to 6½” square.

Make (6) 6½” unfinished Applesauce Cross blocks.

YIELD

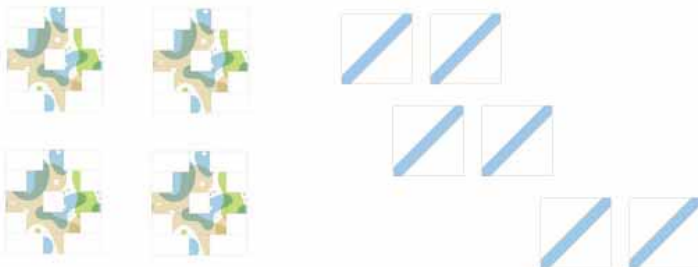

WEEK 1: [Intro to QAL + Fabric Requirements](#)

WEEK 2: [Prairie Rose Garden + 8 Applesauce Cross blocks](#)

WEEK 3: [Tropical Punch + 6 Applesauce Cross blocks](#) {this post}

Oda May

8/28/2017

Original Recipe can be found at www.modabakeshop.com

Recipes are sometimes altered to correct errors. Please ensure that you have downloaded the most recent Printer Friendly Version before starting your project. If you find a mistake in this pattern, please contact modabakeshop@unitednotions.com.

This is an original pattern not intended for sale.

moda BAKE SHOP



MODERATE

A note about ratings for this quilt-along: Overall, the quilt is rated as Moderate, but many of the blocks fall into the Easy category. You will see the ratings vary between Easy and Moderate from week to week. For more information about what these ratings mean, click on the graphic above.

This is part 4 of a 13 part quilt-along series. Find the rest of the posts in this series by clicking on the links at the end of this post.

Welcome to Week 4 in Oda May's School of Sewing! Just one block type this week, but we have 12 to make so let's get started.

Some notes:

- Use a scant $\frac{1}{4}$ " seam.
- Depending on your cutting method, you may have extras each week of common sizes used throughout the quilt. I suggest you label a couple of plastic bags for "2 $\frac{1}{2}$ " squares" and "2 $\frac{7}{8}$ " squares" so you can make use of the extras another week.

Churn Dash

{from [Prairie Traditions](#) by [Cathy Smith](#)}

INGREDIENTS

From 5 Layer Cake squares, cut:

(24) 2 $\frac{7}{8}$ " squares

(48) 1 $\frac{1}{2}$ " x 2 $\frac{1}{2}$ " strips

9/4/2017

Original Recipe can be found at www.modabakeshop.com

Recipes are sometimes altered to correct errors. Please ensure that you have downloaded the most recent Printer Friendly Version before starting your project. If you find a mistake in this pattern, please contact modabakeshop@unitednotions.com.

This is an original pattern not intended for sale.

CUTTING FROM LAYER CAKE

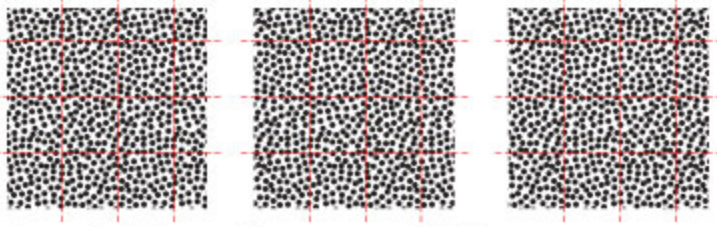

From each of 3 Layer Cake squares, cut (9) $2\frac{7}{8}$ " squares.

From 2 Layer Cake squares, cut (48) $1\frac{1}{2}$ " x $2\frac{1}{2}$ " strips

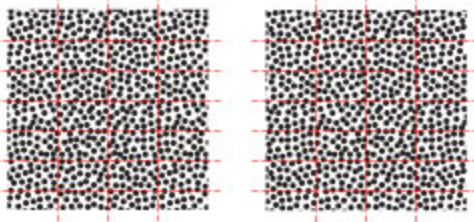

From background fabric, cut:

(24) $2\frac{7}{8}$ " squares

(36) $1\frac{1}{2}$ " x $2\frac{1}{2}$ " strips

(12) $2\frac{1}{2}$ " squares

INSTRUCTIONS

Make Half Square Triangles (HSTs)

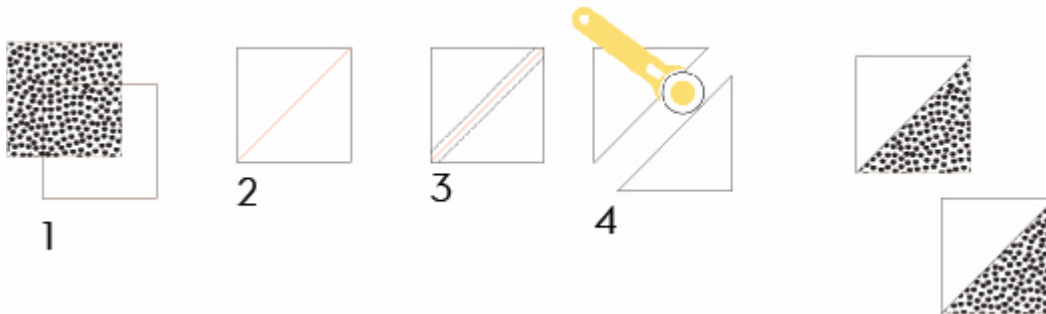

1. Pair (1) $2\frac{7}{8}$ " print square with (1) $2\frac{7}{8}$ " background square.
2. Draw a line along the diagonal of the wrong side of one square.
3. Sew $\frac{1}{4}$ " away from each side of the drawn line.
4. Cut apart at the line. Press towards the darker fabric and trim to $2\frac{1}{2}$ " square.

Repeat to make 48 HST units.

Pair (1) $1\frac{1}{2}$ " x $2\frac{1}{2}$ " print strip with (1) $1\frac{1}{2}$ " x $2\frac{1}{2}$ " background strip. Sew along the long edge and press. Repeat to make (48) sets.

9/4/2017

Original Recipe can be found at www.modabakeshop.com

Recipes are sometimes altered to correct errors. Please ensure that you have downloaded the most recent Printer Friendly Version before starting your project. If you find a mistake in this pattern, please contact modabakeshop@unitednotions.com.

This is an original pattern not intended for sale.

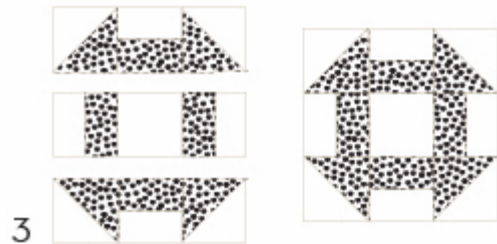
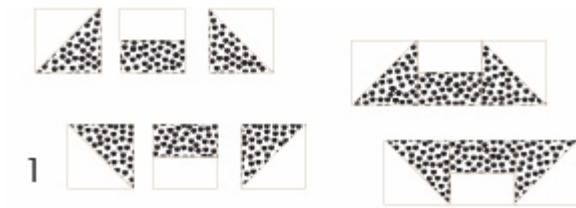

1. Join (2) HST units with rectangle pair as shown. Press.
2. Join (2) rectangle pairs with center square. Press.
3. Assemble block in rows as shown.

Make (12) 6½” unfinished Churn Dash blocks.

YIELD

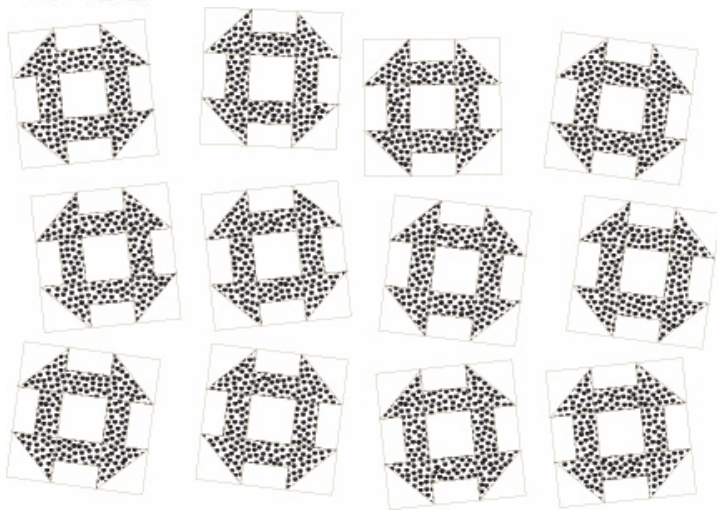

WEEK 1: [Intro to QAL + Fabric Requirements](#)

WEEK 2: [Prairie Rose Garden + 8 Applesauce Cross blocks](#)

WEEK 3: [Tropical Punch + 6 Applesauce Cross blocks](#)

WEEK 4: Churn Dash blocks {this post}

Oda May

9/4/2017

Original Recipe can be found at www.modabakeshop.com

Recipes are sometimes altered to correct errors. Please ensure that you have downloaded the most recent Printer Friendly Version before starting your project. If you find a mistake in this pattern, please contact modabakeshop@unitednotions.com.

This is an original pattern not intended for sale.

moda BAKE SHOP



Figgy Pudding



Applesauce Cross



WEEK 5

MODERATE

This is part 5 of a 13 part quilt-along series. Find the rest of the posts in this series by clicking on the links at the end of this post.

Welcome to Week 5! Oda May had something else planned for this week, but based on the chatter on the [Facebook group](#), we know many of you are itching to get that center block made. So we are helping you out and bumping this block up in the schedule. We also have some more Applesauce Cross blocks to hammer, as well. Your stack of those should be piling up nicely by now but don't worry - we have more to go! ;)

Some notes:

- Use a scant $\frac{1}{4}$ " seam.
- Depending on your cutting method, you may have extras each week of common sizes used throughout the quilt. I suggest you label a couple of plastic bags for " $2\frac{1}{2}$ " squares" and " $2\frac{7}{8}$ " squares" so you can make use of the extras another week.

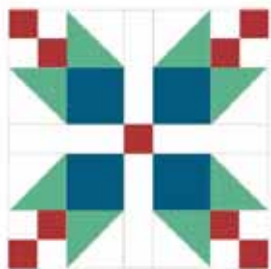

Figgy Pudding

{from [Figgy Pudding Quilt](#) by [Vanessa Goertzen](#)}

INGREDIENTS

*NOTE: This block is great for fat quarters as Vanessa designed it in her quilt. If you'd like to use fat quarters, hop on over to [that post](#) and follow her cutting instructions there.

Select 3 Layer Cake Squares. Set one aside.

From 1 Layer Cake square, cut (4) $4\frac{1}{2}$ " squares

From 1 Layer Cake square, cut (9) $2\frac{1}{2}$ " squares

From the background fabric, cut:

- (1) 10" square
- (8) $2\frac{1}{2}$ " squares
- (4) $2\frac{1}{2}$ " x $8\frac{1}{2}$ " strips

CUTTING FROM LAYER CAKE

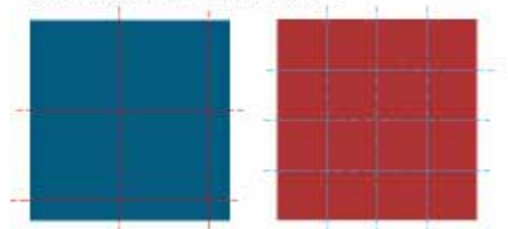

From 1 Layer Cake square, cut (4) $4\frac{1}{2}$ " squares.
From 1 Layer Cake square, cut (9) $2\frac{1}{2}$ " squares.

INSTRUCTIONS

This is a technique for Half-Square Triangles (HSTs) that you may not have seen before! Once you try it, you will love it. It's great for Layer Cakes and definitely one to add to your bag of quilting tricks.

9/11/2017

Original Recipe can be found at www.modabakeshop.com

Recipes are sometimes altered to correct errors. Please ensure that you have downloaded the most recent Printer Friendly Version before starting your project. If you find a mistake in this pattern, please contact modabakeshop@unitednotions.com.

This is an original pattern not intended for sale.

HALF-SQUARE TRIANGLES (HSTs): Mark a diagonal line on the back of the 10" square of background fabric to form an 'X'. Use a ruler to draw an additional set of lines to divide the square into four equal (5" square) sections. Place a marked square right sides together with the 10" square of FABRIC A, aligning raw edges. Sew 1/4" away from the diagonal on both sides, on both diagonals.

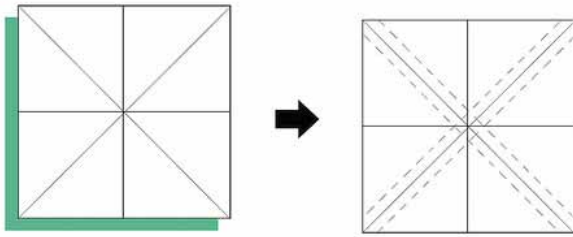

Using your rotary cutter and mat, carefully cut along all drawn lines. Open and press each half-square triangle. Trim each HST to 4½" square.

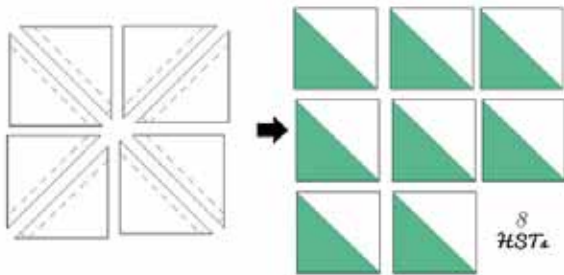

FOUR-PATCH SQUARES: You will need (8) 2½" print squares and (8) 2½" squares of background fabric. Sew together in pairs and press toward the print. Sew two pairs together and press the seams.

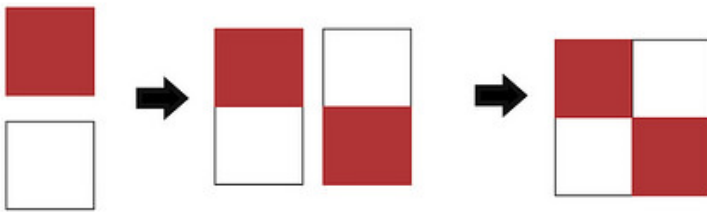

Gather together the 4½" squares, the half-square triangles, and the four patch-squares. Sew the blocks into rows and press the seams. Sew the rows together; press the seams. Make 4.

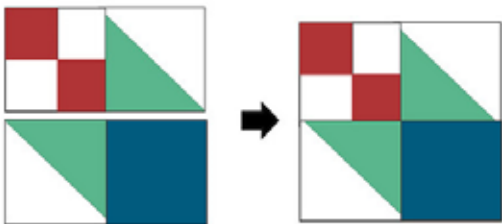

Arrange the 4 blocks as indicated below--with a 2½" x 8½" strip of background fabric separating them, and (1) 2½" square in the center. Sew the block into their rows and press the seams. Sew the rows together; press the seams. Unfinished block should measure 18½" square.

9/11/2017

Original Recipe can be found at www.modabakeshop.com

Recipes are sometimes altered to correct errors. Please ensure that you have downloaded the most recent Printer Friendly Version before starting your project. If you find a mistake in this pattern, please contact modabakeshop@unitednotions.com.

This is an original pattern not intended for sale.

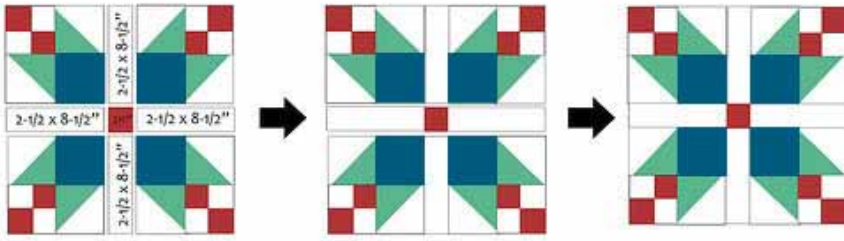

Applesauce Cross

{from [Applesauce Quilt](#) by [Lauren Terry](#)}

INGREDIENTS

NOTE: The quilt features 64 Applesauce Cross blocks spaced out over the quilt-along. You can either make them all at once or make a few at a time.

From accent fabric, cut:
Cut (6) 1½" x 11½" strips

From background fabric, cut:
Cut (6) 6½" squares

INSTRUCTIONS

Make Applesauce Cross Blocks

1. Cut 6½" square in two along the diagonal.
 2. Mark the center of each triangle and accent fabric strip. Line up marks on strip and one triangle and pin. Sew and press.
 3. Align marks on opposite edge of strip and remaining triangle. Pin, sew, and press.
 4. Press and trim to 6½" square.
- Make (6) 6½" unfinished Applesauce Cross blocks.

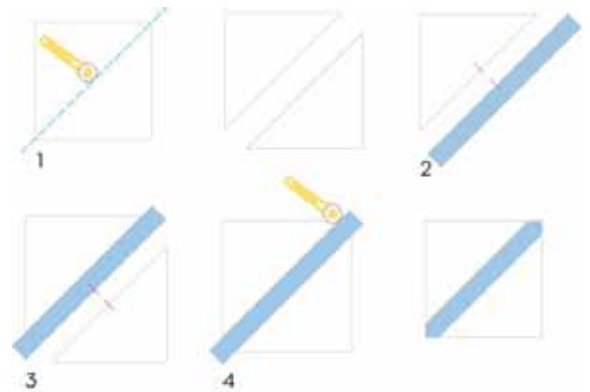

YIELD

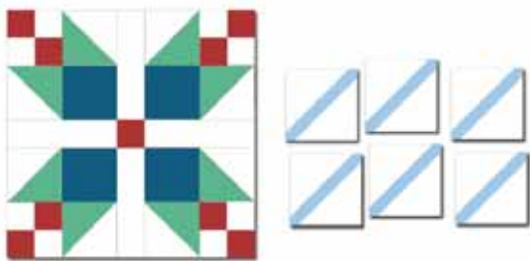

Oda May

[WEEK 1: Intro to QAL + Fabric Reqs](#)

[WEEK 2: Prairie Rose Garden + 8 Applesauce Cross](#)

[WEEK 3: Tropical Punch + 6 Applesauce Cross](#)

[WEEK 4: Churn Dash](#)

[WEEK 5: Figgy Pudding + 6 Applesauce Cross {this post}](#)

9/11/2017

Original Recipe can be found at www.modabakeshop.com

Recipes are sometimes altered to correct errors. Please ensure that you have downloaded the most recent Printer Friendly Version before starting your project. If you find a mistake in this pattern, please contact modabakeshop@unitednotions.com.

This is an original pattern not intended for sale.



Delectable Flowers



WEEK 6

MODERATE

This is part 6 of a 13 part quilt-along series. Find the rest of the posts in this series by clicking on the links at the end of this post.

Welcome to Week 6! This week we are tackling the Delectable Flowers blocks. There are four of these blocks, each made up of 4 smaller units. It's a good chunk of sewing to tackle during a couple of free evenings this week. If you have questions about this block or need more instructions, be sure to click through to the [original post](#).

No Applesauce Cross blocks this week!

Some notes:

- Use a scant $\frac{1}{4}$ " seam.
- Depending on your cutting method, you may have extras each week of common sizes used throughout the quilt. I suggest you label a couple of plastic bags for " $2\frac{1}{2}$ " squares" and " $2\frac{7}{8}$ " squares" so you can make use of the extras another week.

Delectable Flowers

{from [Delectable Flowers Quilt](#) by [Cathy Smith](#)}



INGREDIENTS

8 Layer Cake Squares OR 8 (10)" squares cut from fat quarters

From accent fabric or a Layer Cake square, cut (16) 2" squares

From the background fabric, cut (8) 10" squares and (16) 2" squares

9/17/2017

Original Recipe can be found at www.modabakeshop.com

Recipes are sometimes altered to correct errors. Please ensure that you have downloaded the most recent Printer Friendly Version before starting your project. If you find a mistake in this pattern, please contact modabakeshop@unitednotions.com.

This is an original pattern not intended for sale.

**No cutting layout for this method because we don't cut the Layer Cake before we sew.*

INSTRUCTIONS

Half-Square Triangles (HSTs)

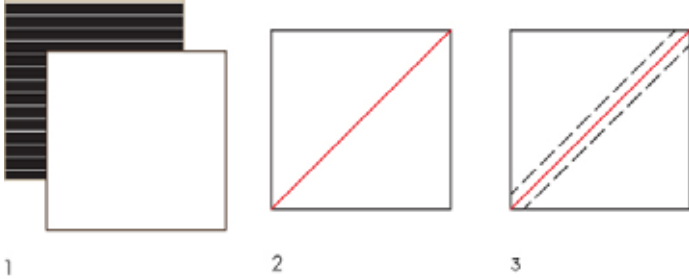

1. Pair each Layer Cake square with a background square.
2. Draw a line on the wrong side of the diagonal of each Layer Cake square OR background print (I find it easier to draw a pencil line on whichever fabric is lighter.) Pin right sides together along the diagonal line.
3. Sew a scant 1/4" seam on each side of the diagonal line.
4. Cut on the diagonal line and press open. Each Layer Cake square yields 2 HSTs, which makes up half a Delectable Flower block.



Square the half-square triangle (HSTs) to 9-1/2" square. Align HSTs as shown. Cut into (4) 2-3/8" strips.

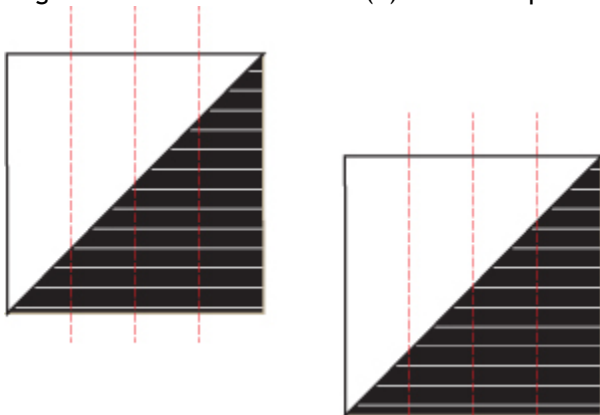

Rearrange strips as shown. Pin and sew together. Repeat to make 16 of these units.



This block unit measures 9-1/2" x 8". Trim 3/4" from the top and bottom to square the blocks up to 8". *This will cut off the top point which is not visible in the graphics shown in these instructions.*

Easy Corner Triangles (ECTs)

9/17/2017

Original Recipe can be found at www.modabakeshop.com

Recipes are sometimes altered to correct errors. Please ensure that you have downloaded the most recent Printer Friendly Version before starting your project. If you find a mistake in this pattern, please contact modabakeshop@unitednotions.com.

This is an original pattern not intended for sale.

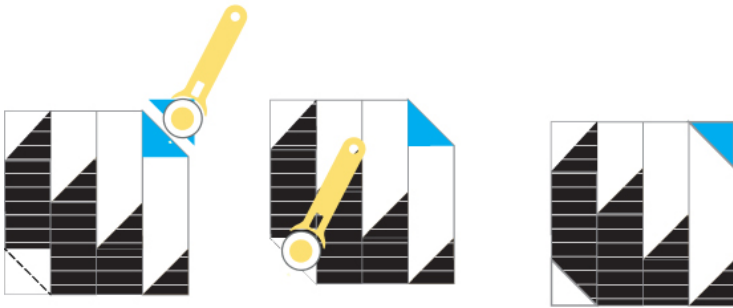
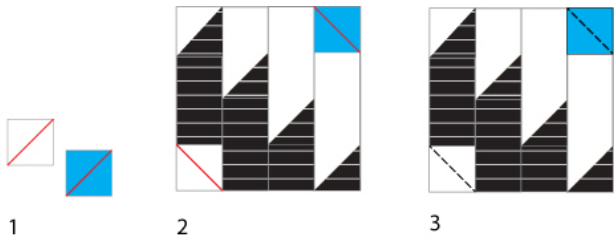

- 4
1. On the wrong side of the fabric, draw a pencil line along the diagonal of each 2" square.
 2. Pin accent square to the top right of the block unit and pin background square to the lower left corner of the unit.
 3. Sew ON the diagonal lines.
 4. Trim 1/4" away from the stitched line and press.

Arrange (4) block units to make a flower as shown. Pin and sew together. Repeat to make a total of 4 Delectable Flower blocks.

YIELD



Oda May

WEEK 1: Intro to QAL + Fabric Reqs

WEEK 2: Prairie Rose Garden + 8 Applesauce Cross

WEEK 3: Tropical Punch + 6 Applesauce Cross

WEEK 4: Churn Dash

WEEK 5: Figgy Pudding + 6 Applesauce Cross

WEEK 6: Delectable Flowers {this post}

9/17/2017

Original Recipe can be found at www.modabakeshop.com

Recipes are sometimes altered to correct errors. Please ensure that you have downloaded the most recent Printer Friendly Version before starting your project. If you find a mistake in this pattern, please contact modabakeshop@unitednotions.com.

This is an original pattern not intended for sale.



ALTERNATE
Delectable Flowers



WEEK 7a

MODERATE

This is part 7a of a 13 part quilt-along series. Find the rest of the posts in this series by clicking on the links at the end of this post.

Welcome to Week 7! This week we have two back-to-back posts. We are offering an alternate method to construct the Delectable Flowers blocks today and tomorrow's post will be a previously scheduled post. Many of you conquered last week's Delectable Flowers without issues, but they are a tricky block and this alternate method results in a square block with no loss of points. However, this method is not necessarily easier. Read through both posts and practice on some scrap fabric to see which method you prefer.

There are four of these blocks, each made up of 4 smaller units. Last week we showed the block with corner triangles on the outer corners. This is a style choice that you may or may not want in your quilt. This block will be surrounded by sashing - that sashing can be background fabric or something to accent and frame the block. The choice is yours but consider the options before you start cutting.

Some notes:

- Use a scant $\frac{1}{4}$ " seam.
- Depending on your cutting method, you may have extras each week of common sizes used throughout the quilt. I suggest you label a couple of plastic bags for " $2\frac{1}{2}$ " squares" and " $2\frac{7}{8}$ " squares" so you can make use of the extras another week.

Delectable Flowers

{from [Delectable Flowers Quilt](#) by [Cathy Smith](#)}



Some notes about this block:

- Take care when cutting the Layer Cake squares. We will cut vertically and diagonally while keeping the fabric in one spot. It may help you to mark the cut lines on the fabric or put tape on your cutting templates at the necessary intervals.
- Eyeball the scant $\frac{1}{4}$ " when pairing block segments. If you are new to sewing triangles, test this out so you can see just how the fabric moves when you sew the seam and press. If you do not offset by a scant $\frac{1}{4}$ ", your triangle will not line up correctly.

INGREDIENTS

8 Layer Cake Squares OR 8 (10)" squares cut from fat quarters

From accent fabric or a Layer Cake square, cut (16) $2\frac{1}{4}$ " squares (optional)

From the background fabric, cut (8) 10" squares and (16) $2\frac{1}{4}$ " squares

9/25/2017

Original Recipe can be found at www.modabakeshop.com

Recipes are sometimes altered to correct errors. Please ensure that you have downloaded the most recent Printer Friendly Version before starting your project. If you find a mistake in this pattern, please contact modabakeshop@unitednotions.com.

This is an original pattern not intended for sale.

INSTRUCTIONS

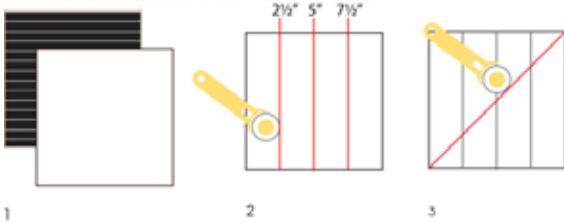

1. Pair each Layer Cake square with a background square.
2. Without moving the fabric, cut the Layer Cake pair at into vertical strips at 2½", 5½" and 7½". (You need (4) 2½" x 10" strips.)
3. Again without moving the fabric, cut along the diagonal of the Layer Cake pair as indicated.
4. Pair up pointed print segments with corresponding pointed background fabric segments.

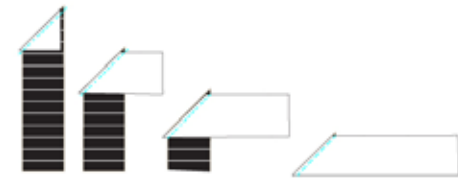
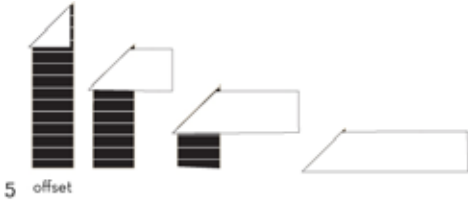

5. With right sides together, offset the top triangle by a scant ¼" on each side of the diagonal line.
6. Sew a scant ¼" seam along the cut edges. Press to the darker fabric. Repeat with each pair. Trim each strip to 8½" tall as indicated.

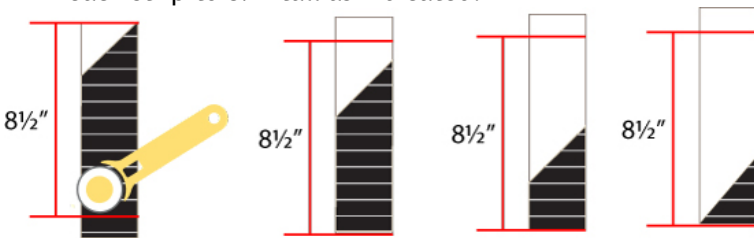

Lay out strips as shown below and sew together.



Trim block unit to 8½" square.

9/25/2017

Original Recipe can be found at www.modabakeshop.com

Recipes are sometimes altered to correct errors. Please ensure that you have downloaded the most recent Printer Friendly Version before starting your project. If you find a mistake in this pattern, please contact modabakeshop@unitednotions.com.

This is an original pattern not intended for sale.

Each Layer Cake square yields 2 of the 4 Delectable Flower units to make up a complete block.

Easy Corner Triangles (ECTs)

Remember, outer ECTs shown in blue are optional depending on the desired look.

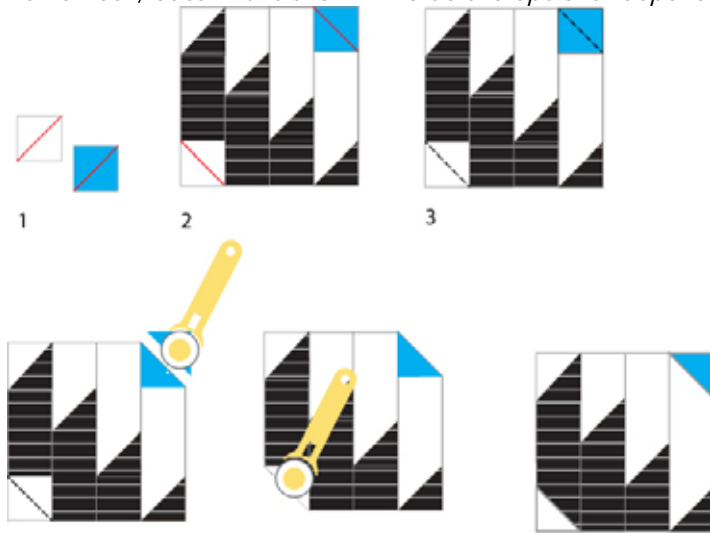

1. On the wrong side of the fabric, draw a pencil line along the diagonal of each 2¼" square.
2. Pin accent square to the top right of the block unit and pin background square to the lower left corner of the unit.
3. Sew ON the diagonal lines.
4. Trim ¼" away from the stitched line and press.

Arrange (4) block units to make a flower as shown. Pin and sew together. Repeat to make a total of 4 Delectable Flower blocks.



YIELD

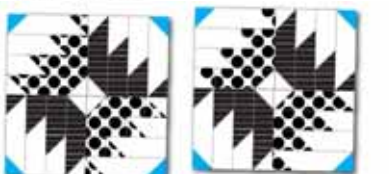

Oda May

WEEK 1: [Intro to QAL + Fabric Reqs](#)

WEEK 2: [Prairie Rose Garden + 8 Applesauce Cross](#)

WEEK 3: [Tropical Punch + 6 Applesauce Cross](#)

WEEK 4: [Churn Dash](#)

WEEK 5: [Figgy Pudding + 6 Applesauce Cross](#)

WEEK 6: [Delectable Flowers](#)

WEEK 7a: [Alternate Delectable Flowers {this post}](#)

9/25/2017

Original Recipe can be found at www.modabakeshop.com

Recipes are sometimes altered to correct errors. Please ensure that you have downloaded the most recent Printer Friendly Version before starting your project. If you find a mistake in this pattern, please contact modabakeshop@unitednotions.com.

This is an original pattern not intended for sale.



MODERATE

This is part 7b of a 13 part quilt-along series. Find the rest of the posts in this series by clicking on the links at the end of this post.

Yes, it's still Week 7! Yesterday we shared the alternate version of the Delectable Flowers blocks. It's not easier but it gives you less to worry about with the points and results in a slightly larger block.

Now today is the scheduled post for the week and a lot of you are going to be happy and some of you who have procrastinated are going to have to face those Applesauce Cross blocks. That's right. This week is all about finishing those blocks up! If you've been keeping up, then you have 25 Applesauce Cross to make in the next 7 days. I suggest making 4 today, 3 tomorrow and repeat until they are all done. However! We still have 6 weeks to go in this quilt-along, including an entire week of catch-up. So work at your own pace and remember that it isn't a race.

Some notes:

- Use a scant $\frac{1}{4}$ " seam.
- Depending on your cutting method, you may have extras each week of common sizes used throughout the quilt. I suggest you label a couple of plastic bags for " $2\frac{1}{2}$ " squares" and " $2\frac{7}{8}$ " squares" so you can make use of the extras another week.

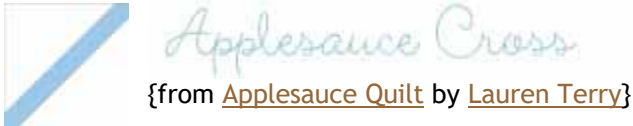

INGREDIENTS

NOTE: The quilt features 64 Applesauce Cross blocks spaced out over the quilt-along. You can either make them all at once or make a few at a time.

From accent fabric, cut:

Cut (6) $1\frac{1}{2}$ " x $11\frac{1}{2}$ " strips

From background fabric, cut:

Cut (6) $6\frac{1}{2}$ " squares

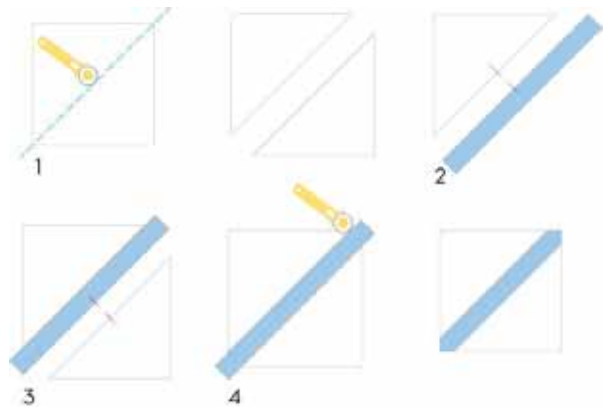

INSTRUCTIONS

Make Applesauce Cross Blocks

1. Cut $6\frac{1}{2}$ " square in two along the diagonal.
2. Mark the center of each triangle and accent fabric strip. Line up marks on strip and one triangle and pin. Sew and press.
3. Align marks on opposite edge of strip and remaining triangle. Pin, sew, and press.
4. Press and trim to $6\frac{1}{2}$ " square.

Make (25) $6\frac{1}{2}$ " unfinished Applesauce Cross blocks.

YIELD



[WEEK 1: Intro to QAL + Fabric Reqs](#)

[WEEK 2: Prairie Rose Garden + 8 Applesauce Cross](#)

[WEEK 3: Tropical Punch + 6 Applesauce Cross](#)

[WEEK 4: Churn Dash](#)

[WEEK 5: Figgy Pudding + 6 Applesauce Cross](#)

[WEEK 6: Delectable Flowers](#)

[WEEK 7a: Alternate Delectable Flowers](#)

[WEEK 7a: Alternate Delectable Flowers {this post}](#)

9/25/2017

Original Recipe can be found at www.modabakeshop.com

Recipes are sometimes altered to correct errors. Please ensure that you have downloaded the most recent Printer Friendly Version before starting your project. If you find a mistake in this pattern, please contact modabakeshop@unitednotions.com.

This is an original pattern not intended for sale.

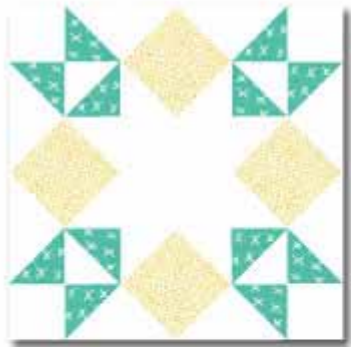

Stack of Stars



WEEK 8

MODERATE

This is part 8 of a 13 part quilt-along series. Find the rest of the posts in this series by clicking on the links at the end of this post.

Just in under the wire here we are at Week 8! This is one of 3 remaining blocks to make in this quilt-along. Can you believe it?!

This block is a combination of half-square triangles and easy corner triangles both of which we have encountered before. The standard is to cut $7/8$ " larger than the unfinished square size for HSTs but many of you on the Facebook chat mentioned cutting a full $1/2$ " larger so go with what makes you comfortable (if you go with the extra $1/2$ " you will be cutting 3" squares from your Layer Cakes).

Stack of Stars

{from [Stacks of Stars Quilt](#) by [Heidi Gwinn](#)}

INGREDIENTS

From 3 Layer Cakes, cut:

- (12) $2\frac{7}{8}$ " squares
- (8) $4\frac{1}{2}$ " squares

From background fabric, cut:

- (2) $4\frac{1}{2}$ " squares
- (12) $2\frac{7}{8}$ " squares
- (40) $2\frac{1}{2}$ " squares

CUTTING FROM LAYER CAKE

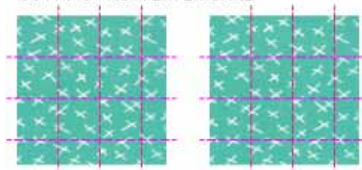

From 2 Layer Cake squares, cut (12) $2\frac{7}{8}$ " squares.

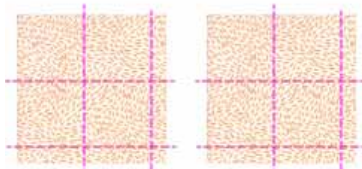

From 2 Layer Cake squares, cut (8) $4\frac{1}{2}$ " squares.

INSTRUCTIONS

Make Half Square Triangles (HSTs)

10/3/2017

Original Recipe can be found at www.modabakeshop.com

Recipes are sometimes altered to correct errors. Please ensure that you have downloaded the most recent Printer Friendly Version before starting your project. If you find a mistake in this pattern, please contact modabakeshop@unitednotions.com.

This is an original pattern not intended for sale.

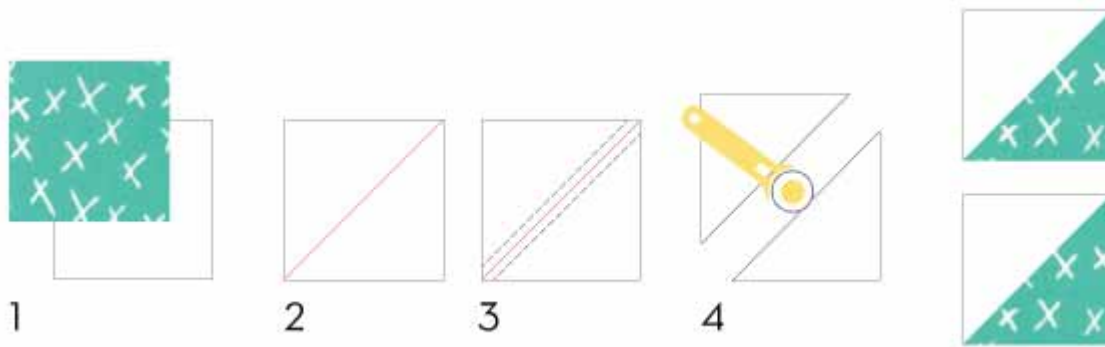

1. Pair (1) $2\frac{7}{8}$ " print square with (1) $2\frac{7}{8}$ " background square.
2. Draw a line along the diagonal of the wrong side of one square.
3. Sew $\frac{1}{4}$ " away from each side of the drawn line.
4. Cut apart at the line. Press towards the darker fabric and trim to $2\frac{1}{2}$ " square.

Repeat to make 24 HST units.

Make Easy Corner Triangles (ECTs)

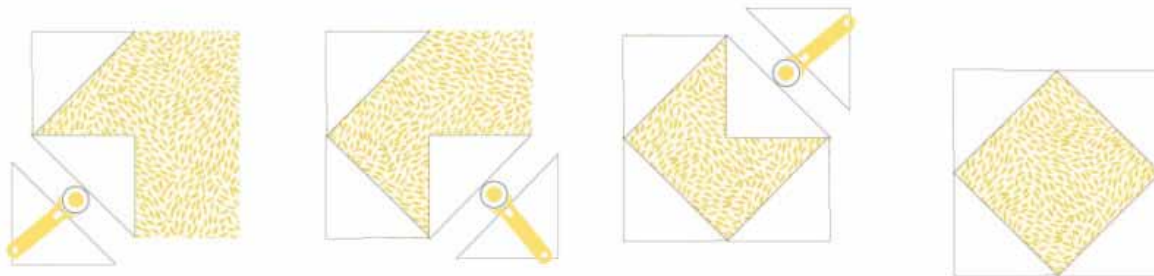
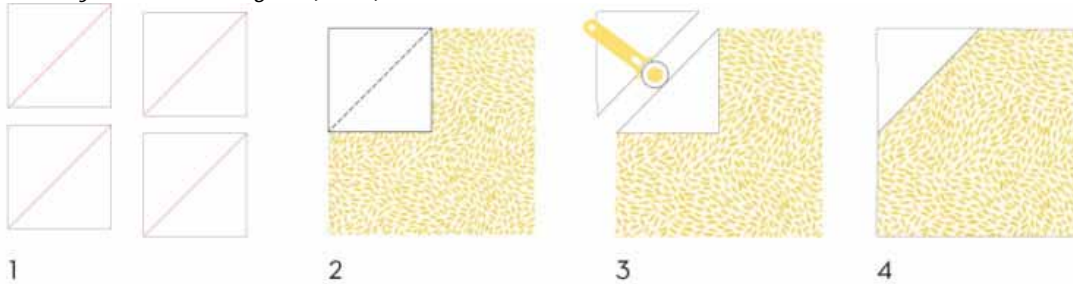

5.
 1. On the wrong side of the fabric, draw a pencil line along the diagonal of each $2\frac{1}{2}$ " background square.
 2. Align background square with one corner of the $4\frac{1}{2}$ " print square. Sew on the diagonal line.
 3. Trim $\frac{1}{4}$ " away from the stitched line and press.
 4. Press.
 5. Repeat with the remaining corners.

Make 8 ECT units.

Assemble block corner units as shown. Make 8.

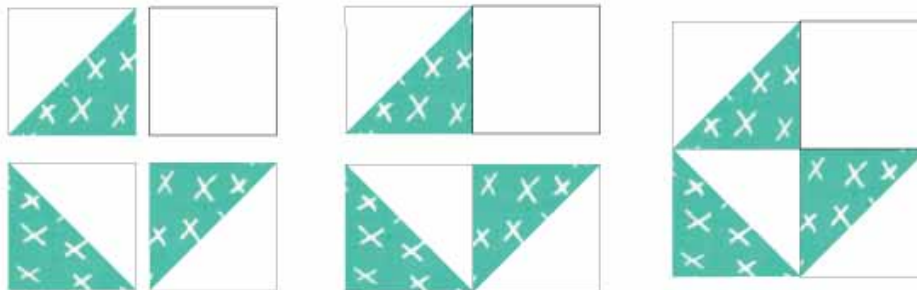

10/3/2017

Original Recipe can be found at www.modabakeshop.com

Recipes are sometimes altered to correct errors. Please ensure that you have downloaded the most recent Printer Friendly Version before starting your project. If you find a mistake in this pattern, please contact modabakeshop@unitednotions.com.

This is an original pattern not intended for sale.

Assemble blocks as shown.

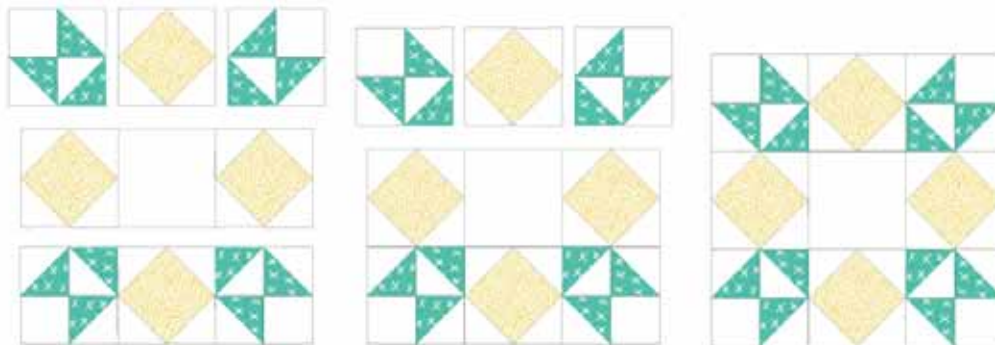

Make 2.

YIELD

(2) 12 1/2" square unfinished Stack of Stars blocks.



Oda May

 *Printer Friendly Version*

[WEEK 1: Intro to QAL + Fabric Reqs](#)

[WEEK 2: Prairie Rose Garden + 8 Applesauce Cross](#)

[WEEK 3: Tropical Punch + 6 Applesauce Cross](#)

[WEEK 4: Churn Dash](#)

[WEEK 5: Figgy Pudding + 6 Applesauce Cross](#)

[WEEK 6: Delectable Flowers](#)

[WEEK 7a: Alternate Delectable Flowers](#)

[WEEK 7b: Applesauce Cross](#)

[WEEK 8: Stacks of Stars {this post}](#)

10/3/2017

Original Recipe can be found at www.modabakeshop.com

Recipes are sometimes altered to correct errors. Please ensure that you have downloaded the most recent Printer Friendly Version before starting your project. If you find a mistake in this pattern, please contact modabakeshop@unitednotions.com.

This is an original pattern not intended for sale.

moda BAKE SHOP

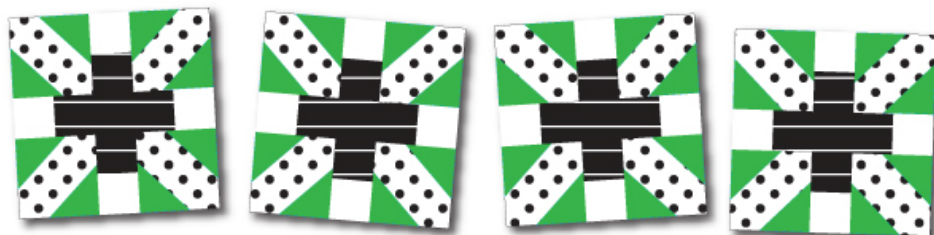

Nough Said



MODERATE

This is part 9 of a 13 part quilt-along series. Find the rest of the posts in this series by clicking on the links at the end of this post.

Welcome to Week 9! We are in the home stretch of this quilt-along and we have four fun blocks to make this week. This block is made up of simple shapes and uses the Easy Corner Triangle method we've done in several blocks already. This block is a good opportunity to have some fun and go scrappy. For an alternate look, substitute the $2\frac{1}{2}$ " x $6\frac{1}{2}$ " strips for $2\frac{1}{2}$ " squares and you can make the center square an accent fabric or get crazy and use your background fabric. ;)

This block measures $10\frac{1}{2}$ " square unfinished.

Some notes:

- Use a scant $\frac{1}{4}$ " seam.
- Depending on your cutting method, you may have extras each week of common sizes used throughout the quilt. I suggest you label a couple of plastic bags for " $2\frac{1}{2}$ " squares" and " $2\frac{7}{8}$ " squares" so you can make use of the extras another week.

'Nough Said

{from 'Nough Said Layer Cake Quilt by [Cindy Sharp](#)}

INGREDIENTS

From (6) Layer Cake squares, cut:

- (16) 5" squares
- (4) $2\frac{1}{2}$ " x $6\frac{1}{2}$ " strips
- (8) $2\frac{1}{2}$ " squares



11/10/2017

Original Recipe can be found at www.modabakeshop.com

Recipes are sometimes altered to correct errors. Please ensure that you have downloaded the most recent Printer Friendly Version before starting your project. If you find a mistake in this pattern, please contact modabakeshop@unitednotions.com.

This is an original pattern not intended for sale.

From accent fabric, cut (32) 3 1/8" squares for Easy Corner Triangles (ECTs)

From background fabric, cut (16) 2 1/2" squares

CUTTING FROM LAYER CAKE

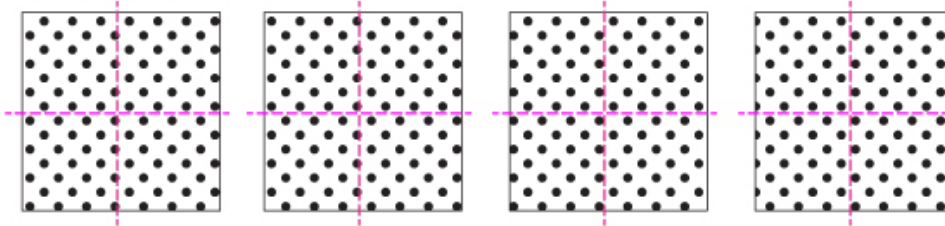

From 4 Layer Cake square, cut (16) 5" squares.

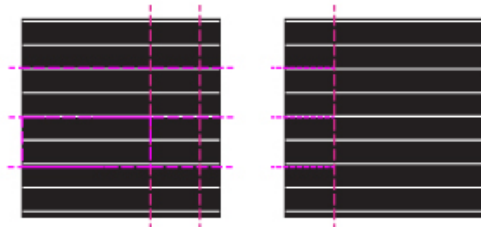

From 2 Layer Cake squares, cut (4) 2 1/2" x 6 1/2" strips and (8) 2 1/2" squares.

INSTRUCTIONS

Make Easy Corner Triangles (ECTs)

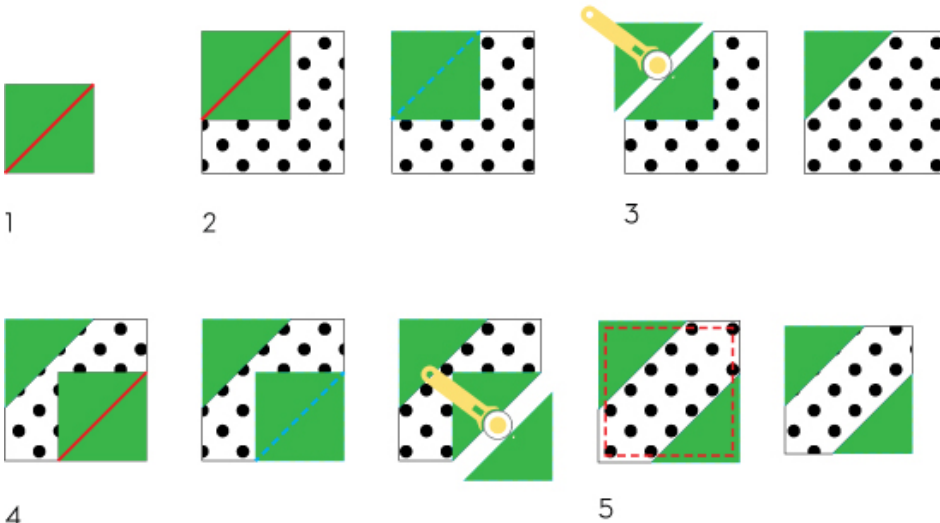

1. Draw a diagonal line on the wrong side of each accent square.
2. Align the accent square in one corner of one 5" square (take care with directional fabrics by planning out your block layout before you start sewing). Sew on the marked line.
3. Trim 1/4" away from the seam and press.
4. Repeat on the opposite corner of the 5" square.
5. Trim block to 4 1/2".

Repeat steps 1 through 5 to make 16 Easy Corner Triangle blocks.

11/10/2017

Original Recipe can be found at www.modabakeshop.com

Recipes are sometimes altered to correct errors. Please ensure that you have downloaded the most recent Printer Friendly Version before starting your project. If you find a mistake in this pattern, please contact modabakeshop@unitednotions.com.

This is an original pattern not intended for sale.

Assemble 'Nough Said blocks as shown. Make 4.



YIELD

(4) 10½" unfinished 'Nough Said' blocks.

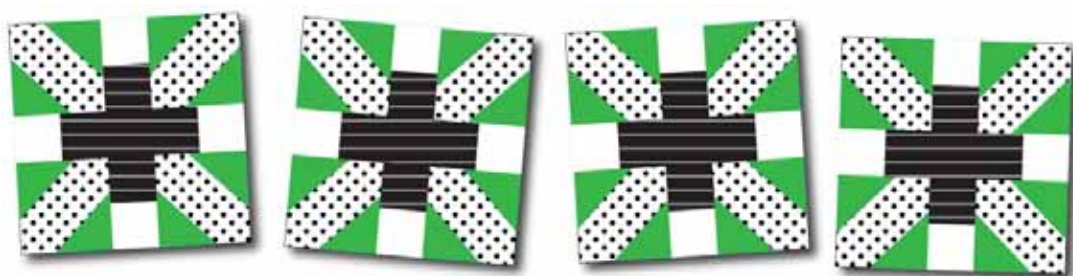

Oda May

WEEK 1: Intro to QAL + Fabric Reqs

WEEK 2: Prairie Rose Garden + 8 Applesauce Cross

WEEK 3: Tropical Punch + 6 Applesauce Cross

WEEK 4: Churn Dash

WEEK 5: Figgy Pudding + 6 Applesauce Cross

WEEK 6: Delectable Flowers

WEEK 7a: Alternate Delectable Flowers

WEEK 7b: Applesauce Cross

WEEK 8: Stacks of Stars

WEEK 9: 'Nough Said {this post}

11/10/2017

Original Recipe can be found at www.modabakeshop.com

Recipes are sometimes altered to correct errors. Please ensure that you have downloaded the most recent Printer Friendly Version before starting your project. If you find a mistake in this pattern, please contact modabakeshop@unitednotions.com.

This is an original pattern not intended for sale.

moda BAKE SHOP

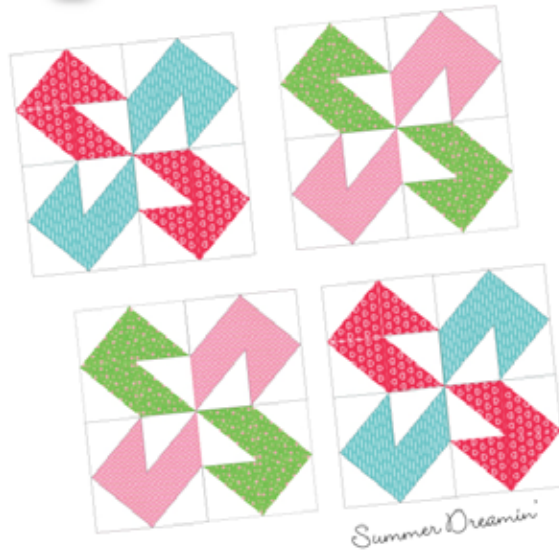

MODERATE

This is part 10 of a 13 part quilt-along series. Find the rest of the posts in this series by clicking on the links at the end of this post.

Welcome to Week 10! This is our *last* block in the quilt-along. Our remaining weeks will be spent on catching up, some tips from other participants, assembling the final quilt top, and some photos of finished quilts. This block is named Summer Dreamin' which is pretty appropriate considering we have just started to feel some cool weather down here in Texas.

This block is small and simple and uses the handy dandy half-square triangle we have encountered many times in the last few weeks. The Chef's original design for this block was 16" finished but we have shrunk it down to 8" finished. Each HST unit finishes at 2" - cutting instructions are for 2 $\frac{7}{8}$ " squares but cut to 3" if that's what you are comfortable with.

Some notes:

- Use a scant $\frac{1}{4}$ " seam.
- Depending on your cutting method, you may have extras each week of common sizes used throughout the quilt. I suggest you label a couple of plastic bags for "2 $\frac{1}{2}$ " squares" and "2 $\frac{7}{8}$ " squares" so you can make use of the extras another week.

Summer Dreamin'

{from [Summer Dreamin'](#) by [Kaye Prince](#)}

10/16/2017

Original Recipe can be found at www.modabakeshop.com

Recipes are sometimes altered to correct errors. Please ensure that you have downloaded the most recent Printer Friendly Version before starting your project. If you find a mistake in this pattern, please contact modabakeshop@unitednotions.com.

This is an original pattern not intended for sale.

INGREDIENTS

From 4 Layer Cakes, cut (32) 2 $\frac{7}{8}$ " squares

CUTTING FROM LAYER CAKE

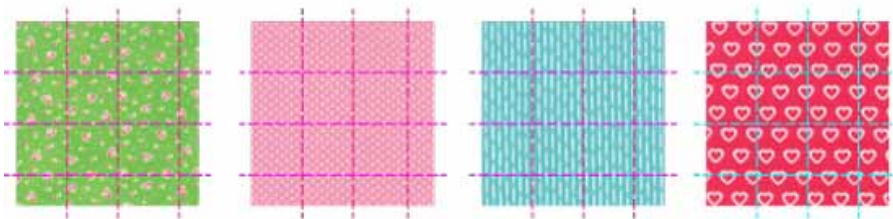

From 4 Layer Cake squares, cut (32) 2 $\frac{7}{8}$ " squares.

From background fabric, cut (32) 2 $\frac{7}{8}$ " squares



INSTRUCTIONS

Make Half Square Triangles (HSTs)



1



2



3



4



1. Pair (1) 2 $\frac{7}{8}$ " print square with (1) 2 $\frac{7}{8}$ " background square.
2. Draw a line along the diagonal of the wrong side of one square.
3. Sew $\frac{1}{4}$ " away from each side of the drawn line.
4. Cut apart at the line. Press towards the darker fabric and trim to 2 $\frac{1}{2}$ " square.

Repeat to make 64 HST units.

Assemble block as shown.



Make 4.

10/16/2017

Original Recipe can be found at www.modabakeshop.com

Recipes are sometimes altered to correct errors. Please ensure that you have downloaded the most recent Printer Friendly Version before starting your project. If you find a mistake in this pattern, please contact modabakeshop@unitednotions.com.

This is an original pattern not intended for sale.

YIELD

(4) 8 1/2" square unfinished Summer Dreamin' blocks.

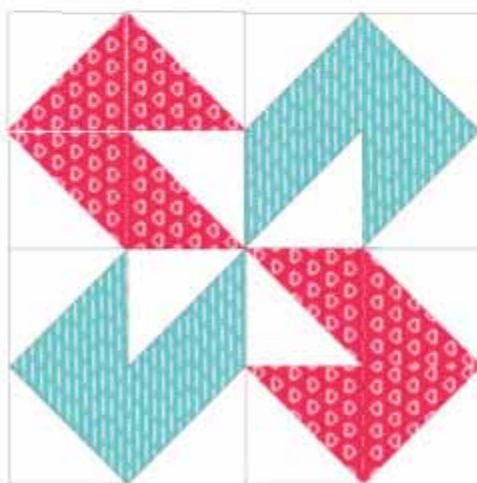
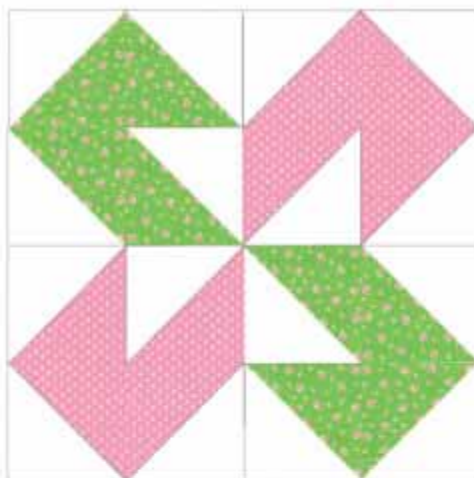
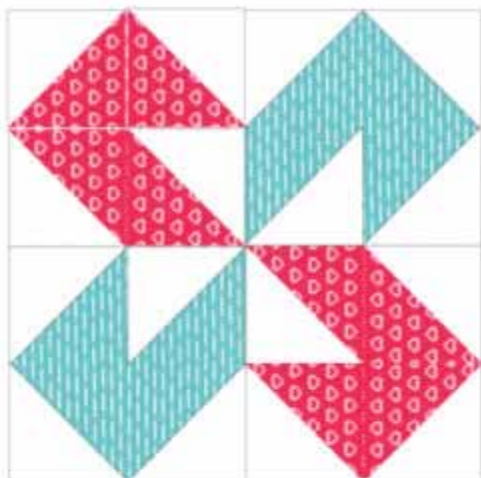

Oda May

WEEK 1: Intro to QAL + Fabric Reqs

WEEK 2: Prairie Rose Garden + 8 Applesauce Cross

WEEK 3: Tropical Punch + 6 Applesauce Cross

WEEK 4: Churn Dash

WEEK 5: Figgy Pudding + 6 Applesauce Cross

WEEK 6: Delectable Flowers

WEEK 7a: Alternate Delectable Flowers

WEEK 7b: Applesauce Cross

WEEK 8: Stacks of Stars

WEEK 9: 'Nough Said

WEEK 10: Summer Dreamin' {this post}

10/16/2017

Original Recipe can be found at www.modabakeshop.com

Recipes are sometimes altered to correct errors. Please ensure that you have downloaded the most recent Printer Friendly Version before starting your project. If you find a mistake in this pattern, please contact modabakeshop@unitednotions.com.

This is an original pattern not intended for sale.

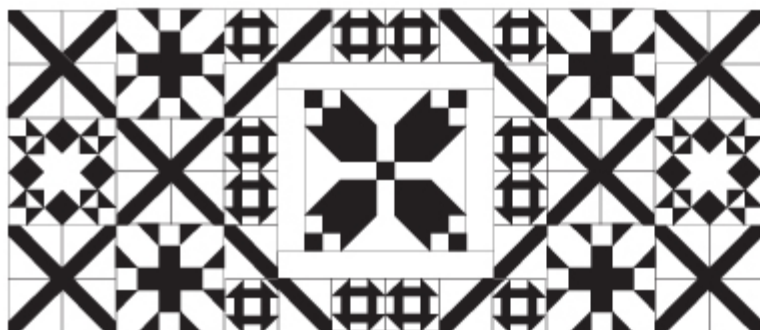

WEEK 12 - Part 1

Quilt Top Assembly

MODERATE

This is part 12a of a 13 part quilt-along series. Find the rest of the posts in this series by clicking on the links at the end of this post.

Welcome to Week 12! This is the week when everything comes together. We will be doing a two-part post simply because it's a lot of information to squeeze into one post. Today we will put together the middle of the quilt and tomorrow the top and bottom plus borders.

The quilt top is made up of 97 blocks (64 Applesauce Cross and 33 others), filler and borders. We will assemble it in sections, starting with the center. Measurements shown for sashing are UNFINISHED. Cut your sashing to the measurements listed.

The sashing on this quilt is a great opportunity to add more scrappiness and/or color to your quilt. Don't be afraid to get creative! Piano key borders or colorful accent fabrics would really make your blocks pop. However if that's just not your style, just stick to the drawing and use the same background fabric everywhere.

Let's get started!

Center Section

INGREDIENTS

- (1) Figgy Pudding block
- (8) Applesauce Cross blocks
- (12) Churn Dash blocks
- (2) sashing strips measuring 3½" x 18½"
- (2) sashing strips measuring 3½" x 24½"

INSTRUCTIONS

Add sashing strips to Figgy Pudding block, starting with the shorter pieces. Press.

10/29/2017

Original Recipe can be found at www.modabakeshop.com

Recipes are sometimes altered to correct errors. Please ensure that you have downloaded the most recent Printer Friendly Version before starting your project. If you find a mistake in this pattern, please contact modabakeshop@unitednotions.com.

This is an original pattern not intended for sale.

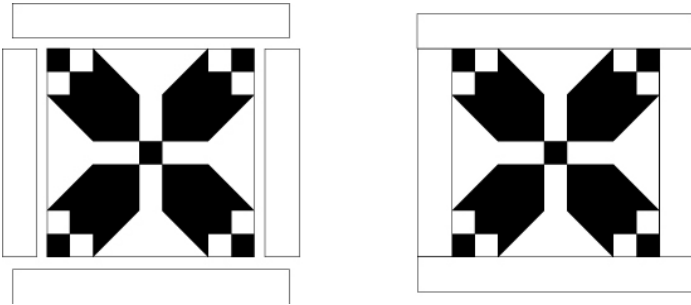

Sew two columns starting at the top with 1 Churn Dash block, 2 Applesauce Cross blocks, 1 Churn Dash block. Be sure the Applesauce Cross blocks are facing opposite directions as shown in the image below. Sew these columns to each side of the sashed Figgy Pudding block.

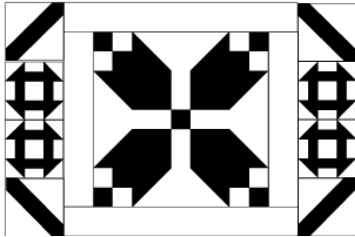
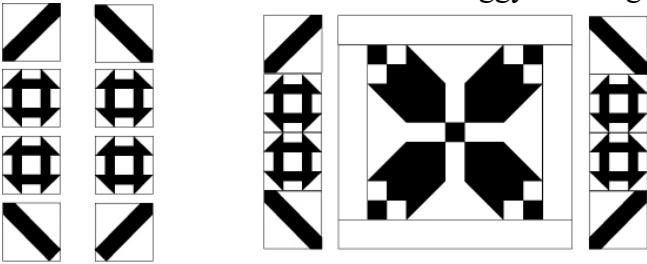

Sew two rows of 1 Churn Dash, 1 Applesauce Cross, 2 Churn Dashes, 1 Applesauce Cross, 1 Churn Dash. Be sure the Applesauce Cross blocks are facing the direction shown in the image below. Add these rows to the top and bottom of the Figgy Pudding row.

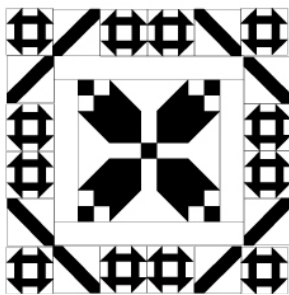
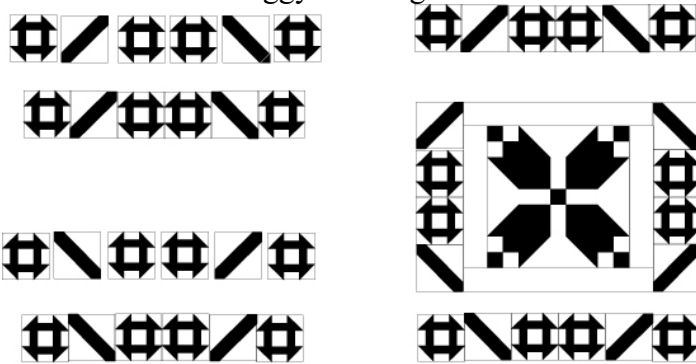

10/29/2017

Original Recipe can be found at www.modabakeshop.com

Recipes are sometimes altered to correct errors. Please ensure that you have downloaded the most recent Printer Friendly Version before starting your project. If you find a mistake in this pattern, please contact modabakeshop@unitednotions.com.

This is an original pattern not intended for sale.

Side Section

- (4) 'Nough Said blocks
- (24) Applesauce Cross blocks
- (2) Stack of Stars blocks

Join 4 Applesauce Cross blocks to create an X. Repeat to make 6 of these units.

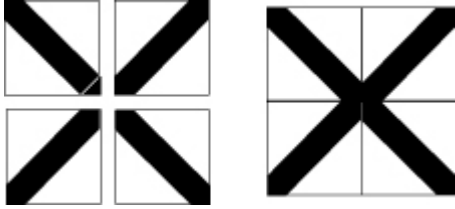

Join each of these X blocks with a 'Nough Said block and Stack of Stars block as shown. Be sure to make a "right" side and "left" side version as shown.

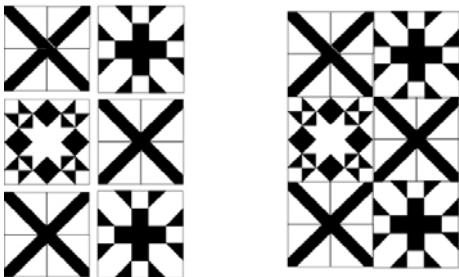
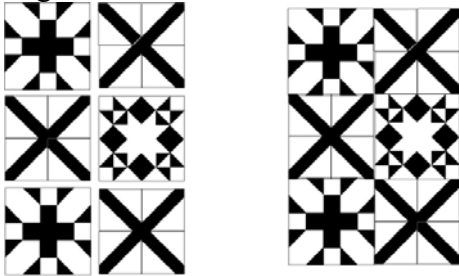

Make the Middle

Now join the left side to the center and add the right side.

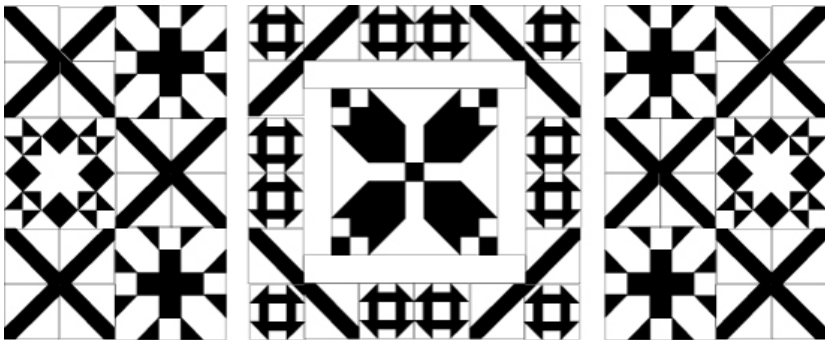

This makes up the middle of the quilt top.

10/29/2017

Original Recipe can be found at www.modabakeshop.com

Recipes are sometimes altered to correct errors. Please ensure that you have downloaded the most recent Printer Friendly Version before starting your project. If you find a mistake in this pattern, please contact modabakeshop@unitednotions.com.

This is an original pattern not intended for sale.

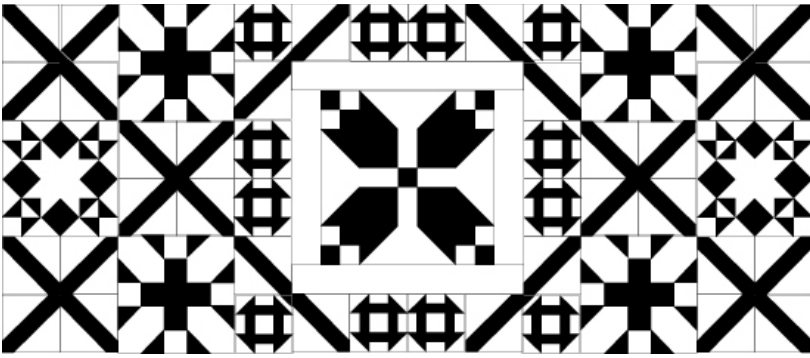

YIELD

(1) quilt torso! The head and the feet are mirror images of each other and they come tomorrow. This middle section should measure 84.5" wide and 36.5" tall.

Oda May

[WEEK 1: Intro to QAL + Fabric Reqs](#)

[WEEK 2: Prairie Rose Garden + 8 Applesauce Cross](#)

[WEEK 3: Tropical Punch + 6 Applesauce Cross](#)

[WEEK 4: Churn Dash](#)

[WEEK 5: Figgy Pudding + 6 Applesauce Cross](#)

[WEEK 6: Delectable Flowers](#)

[WEEK 7a: Alternate Delectable Flowers](#)

[WEEK 7b: Applesauce Cross](#)

[WEEK 8: Stacks of Stars](#)

[WEEK 9: 'Nough Said](#)

[WEEK 10: Summer Dreamin'](#)

[WEEK 11: Catch a Break](#)

[WEEK 12: Quilt Assembly {this post}](#)

10/29/2017

Original Recipe can be found at www.modabakeshop.com

Recipes are sometimes altered to correct errors. Please ensure that you have downloaded the most recent Printer Friendly Version before starting your project. If you find a mistake in this pattern, please contact modabakeshop@unitednotions.com.

This is an original pattern not intended for sale.

moda BAKE SHOP



MODERATE

This is part 12a of a 13 part quilt-along series. Find the rest of the posts in this series by clicking on the links at the end of this post.

This is it! Today we are putting together the top and bottom sections and then the entire quilt top! As you're working, don't forget to take into account that each corner is different. So pay attention to your directional fabrics and especially the direction of the Applesauce Cross blocks.

Let's get started!

Corners

INGREDIENTS

- (6) Applesauce Cross blocks
- (1) Summer Dreamin' block
- (1) Tropical Punch block
- (2) sashing strips measuring $1\frac{1}{2}$ " x $16\frac{1}{2}$ "*
- (2) sashing strips measuring $1\frac{1}{2}$ " x $18\frac{1}{2}$ "*
- (1) sashing strip measuring $2\frac{1}{2}$ " x $10\frac{1}{2}$ "
- (2) sashing strips measuring $2\frac{1}{2}$ " x $8\frac{1}{2}$ "
- (1) sashing strip measuring $2\frac{1}{2}$ " x $6\frac{1}{2}$ "
- (1) sashing strips measuring $6\frac{1}{2}$ " x $12\frac{1}{2}$ "
- (1) sashing strips measuring $4\frac{1}{2}$ " x $6\frac{1}{2}$ "

*These sashing strips may vary depending on the size of your unfinished Delectable Flowers block. The block plus any required sashing needs to measure $18\frac{1}{2}$ " unfinished to fill the space.

INSTRUCTIONS

Add sashing strips as needed to the Delectable Flowers block, starting with the shorter pieces. Press.

11/2/2017

Original Recipe can be found at www.modabakeshop.com

Recipes are sometimes altered to correct errors. Please ensure that you have downloaded the most recent Printer Friendly Version before starting your project. If you find a mistake in this pattern, please contact modabakeshop@unitednotions.com.

This is an original pattern not intended for sale.

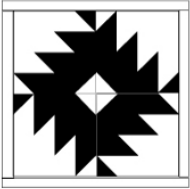

Sew (1) $2\frac{1}{2}'' \times 8\frac{1}{2}''$ to the top and bottom of the Summer Dreamin' block. Sew (1) $2\frac{1}{2}'' \times 6\frac{1}{2}''$ to one side of 1 Applesauce Cross block. Join these units together as shown.

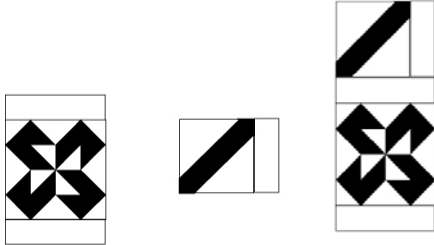

Sew (1) $2\frac{1}{2}'' \times 10\frac{1}{2}''$ to the bottom of the Tropical Punch block. Sew (1) $4\frac{1}{2}'' \times 6\frac{1}{2}''$ sashing piece to one side of 1 Applesauce Cross block. Join these units together as shown.

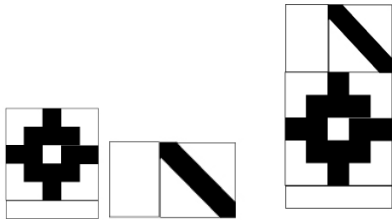

Sew (2) Applesauce Cross blocks together to make a V shape. Repeat to make a second V shape. Join these units with (1) $6\frac{1}{2}'' \times 12\frac{1}{2}''$ sashing piece in between.



Assemble the corner unit. Each corner is different. Only the top left corner unit is shown. See below for each corner unit.

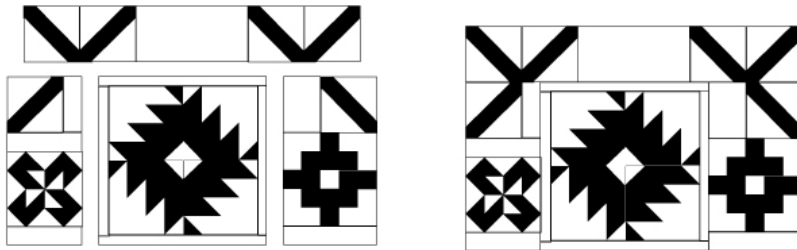

Top Left Corner

The four corners of the quilt top:

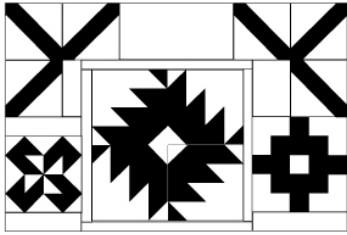

Top Left Corner

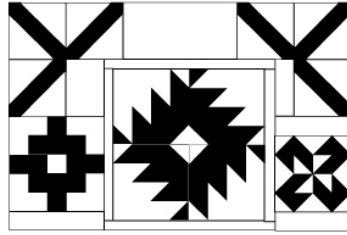

Top Right Corner

Bottom Left Corner

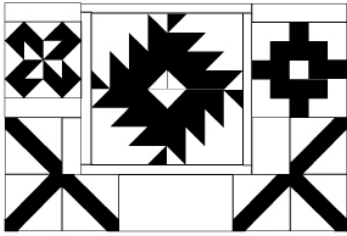

Bottom Right Corner

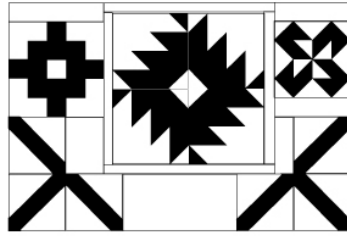

Top and Bottom Centers

(2) Prairie Rose Garden block

(8) Applesauce Cross blocks

Join 4 Applesauce Cross blocks to create an X. Repeat to make 2 of these units.

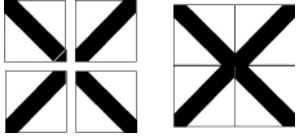

Join each of these X blocks with a 'Prairie Rose Garden' block as shown. Be sure to make both a "top" and "bottom" version as shown.

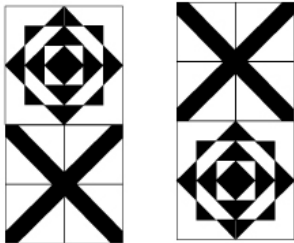

Make the Top and Bottom

Now join each corner unit with a top center unit to make the top section.

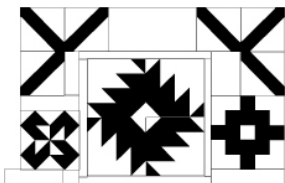

Top Left Corner

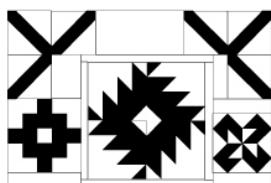

Top Right Corner

11/2/2017

Original Recipe can be found at www.modabakeshop.com

Recipes are sometimes altered to correct errors. Please ensure that you have downloaded the most recent Printer Friendly Version before starting your project. If you find a mistake in this pattern, please contact modabakeshop@unitednotions.com.

This is an original pattern not intended for sale.

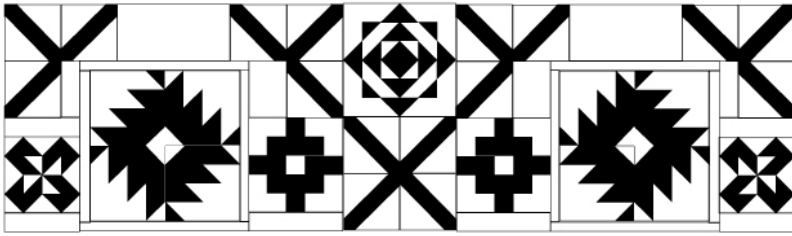

Repeat with the bottom corners and center to make the bottom section.

Bottom Left Corner

Bottom Right Corner

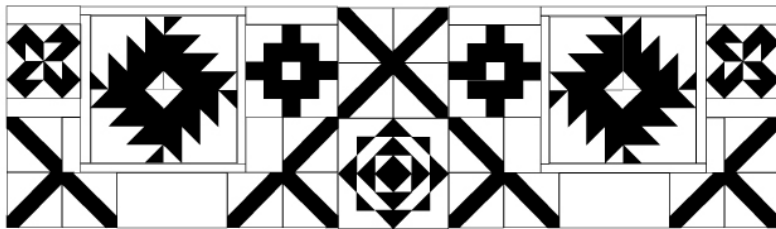
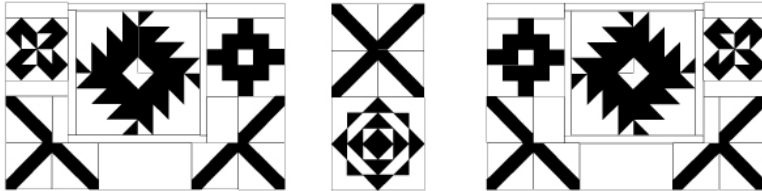

The top and bottom sections should both measure 84½" and 24½" tall.

Assemble the Quilt

Combine the tops and bottoms with the center made previously.

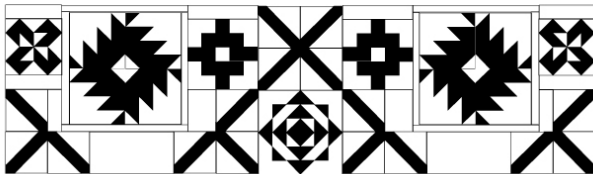
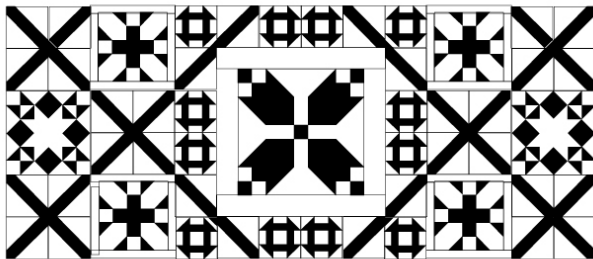
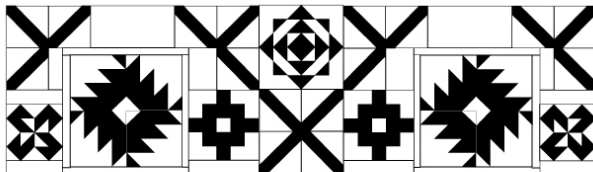

Add borders as desired. It was designed for a 2½" wide border on each side to float the blocks and keep the corners from disappearing under the binding. Before borders the quilt top measures 84½" square.

11/2/2017

Original Recipe can be found at www.modabakeshop.com

Recipes are sometimes altered to correct errors. Please ensure that you have downloaded the most recent Printer Friendly Version before starting your project. If you find a mistake in this pattern, please contact modabakeshop@unitednotions.com.

This is an original pattern not intended for sale.

Cut the selvages off border fabric and press. Cut (9) 2½" x WOF strips. Sew together end to end. Cut (2) 84½" long strips for top and bottom borders and (2) 88½" strips for side borders.

YIELD

(1) quilt top! The finished quilt is square, measuring 84" without borders and 88" with borders.

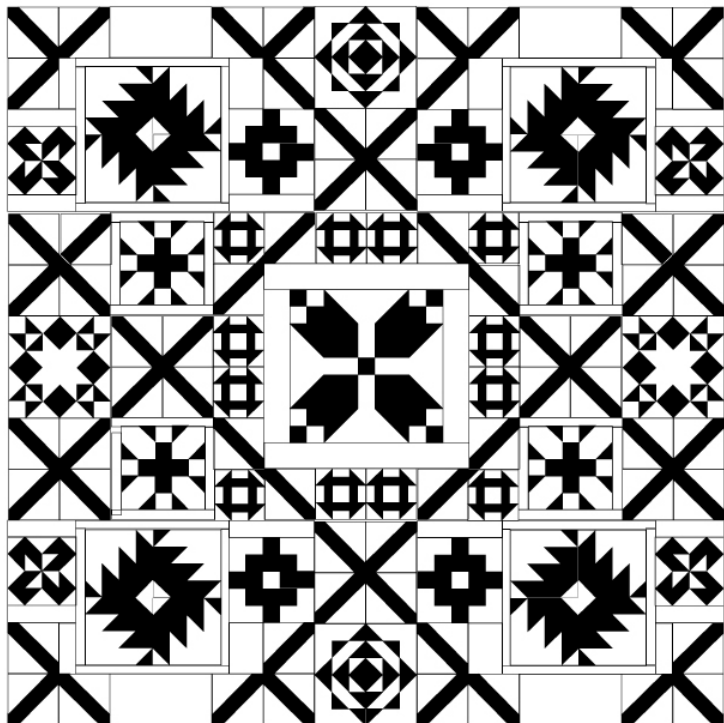

Oda May

[WEEK 1: Intro to QAL + Fabric Reqs](#)

[WEEK 2: Prairie Rose Garden + 8 Applesauce Cross](#)

[WEEK 3: Tropical Punch + 6 Applesauce Cross](#)

[WEEK 4: Churn Dash](#)

[WEEK 5: Figgy Pudding + 6 Applesauce Cross](#)

[WEEK 6: Delectable Flowers](#)

[WEEK 7a: Alternate Delectable Flowers](#)

[WEEK 7b: Applesauce Cross](#)

[WEEK 8: Stacks of Stars](#)

[WEEK 9: 'Nough Said](#)

[WEEK 10: Summer Dreamin'](#)

[WEEK 11: Catch a Break](#)

[WEEK 12a: Quilt Assembly](#)

[WEEK 12b: Quilt Assembly {this post}](#)

11/2/2017

Original Recipe can be found at www.modabakeshop.com

Recipes are sometimes altered to correct errors. Please ensure that you have downloaded the most recent Printer Friendly Version before starting your project. If you find a mistake in this pattern, please contact modabakeshop@unitednotions.com.

This is an original pattern not intended for sale.